



Ballpool set up instructions

No tools required

IMPORTANT! Follow instructions in proper sequence, starting from bottom

6. Unfold and lay the canopy upside down on the floor. The underside of the canopy has 6 pockets through which the canopy rods are to be inserted (One rod is pre-inserted to show how the others are to be done). Firmly push the adapter end of each canopy rod onto each leg of the canopy cap until they snap into place (One rod is already snapped onto a leg of the canopy cap to show how the others are to be done). Turn the canopy right side up and carefully place it on top of the posts (have someone help if needed). The bent tips of the canopy rods are to be inserted downward into the holes in the corner joints on the upper frame assembly. Push downward firmly until they snap into place.

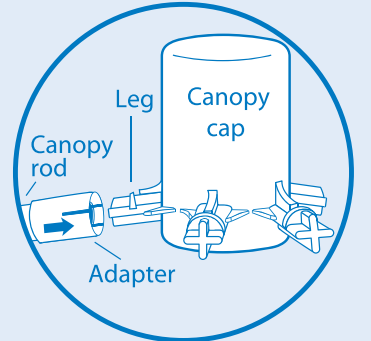
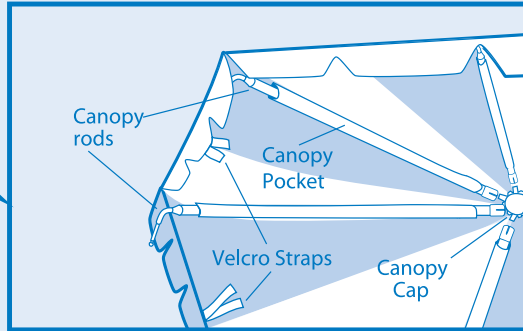
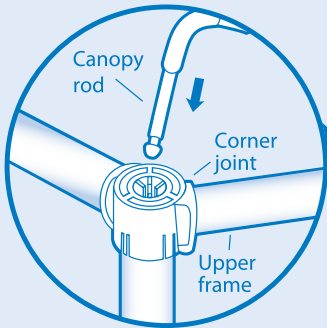
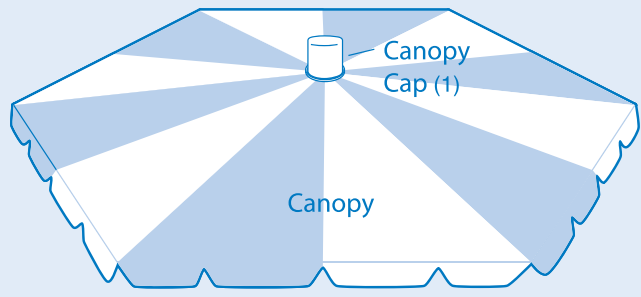

Upper frame assembly

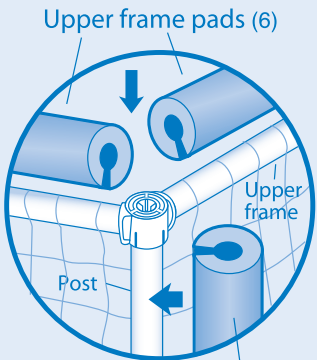
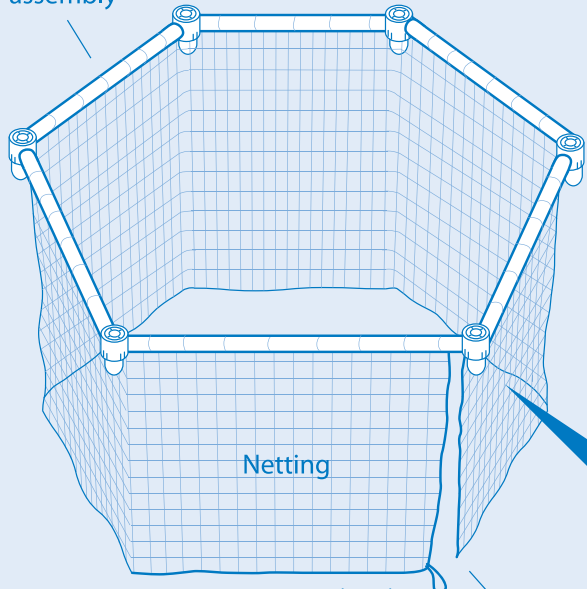

5. Add the shorter pads to the upper frame assembly and the longer pads to the posts. Simply press the slit in the foam pads over the posts and upper frame assembly.

4. Carefully lift upper frame assembly (have someone help you if needed) and set it on top of the posts with the net hanging down **INSIDE** the posts. The opening in the net should be on the **ENTRANCE** side of the ballpool as you align the corners. The dome shaped protrusions fit down into the top of the posts. Press each corner down firmly to lock the upper frame and posts together.

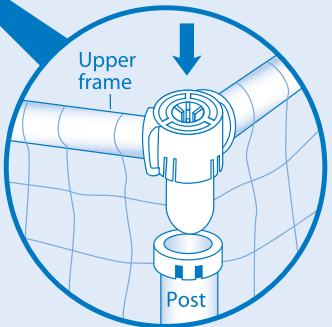

3. Insert posts through holes in foam pad, through the metal rings in each corner and press onto dome-shaped anchors at bottom and turn gently until it snap locks. (anchors are not visible under the balls, you will have to feel for the anchor.)

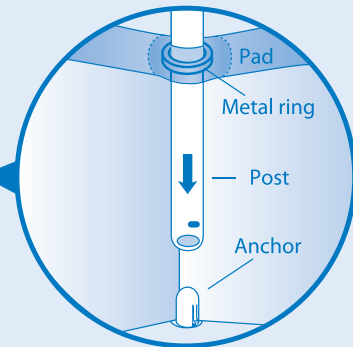

2. On the 2 long foam pads, observe the holes, half-moon holes and slits. Press the slits over the rim of the ballpool with the half-moon holes positioned to the inside of the ballpool. The pad with the red fabric sleeve should be installed so that the sleeve is at the **ENTRANCE**. Align holes in the pads with the metal rings in the corners (through which the metal posts are later inserted as shown in Step 3).

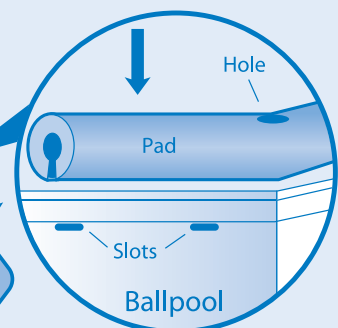

1. Take out and lay aside all the components packed on top of the balls in the ballpool. Do a quick inventory to make sure you have all parts.

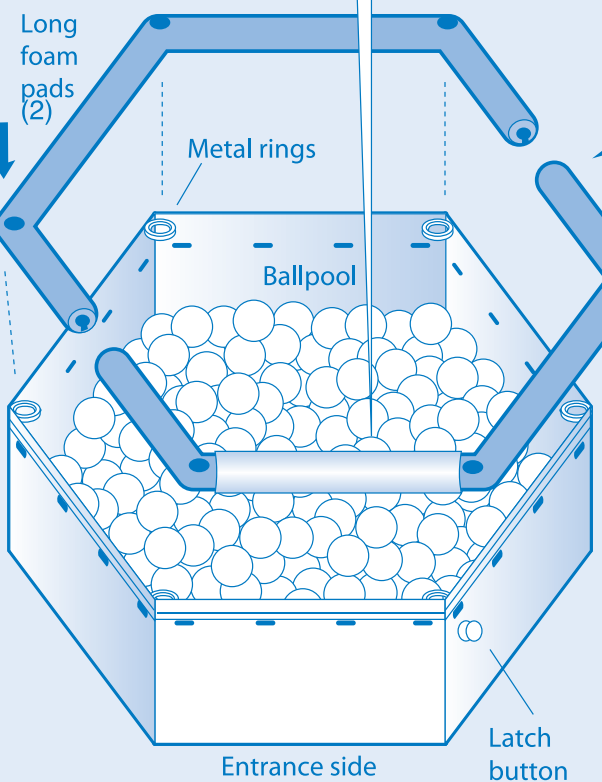
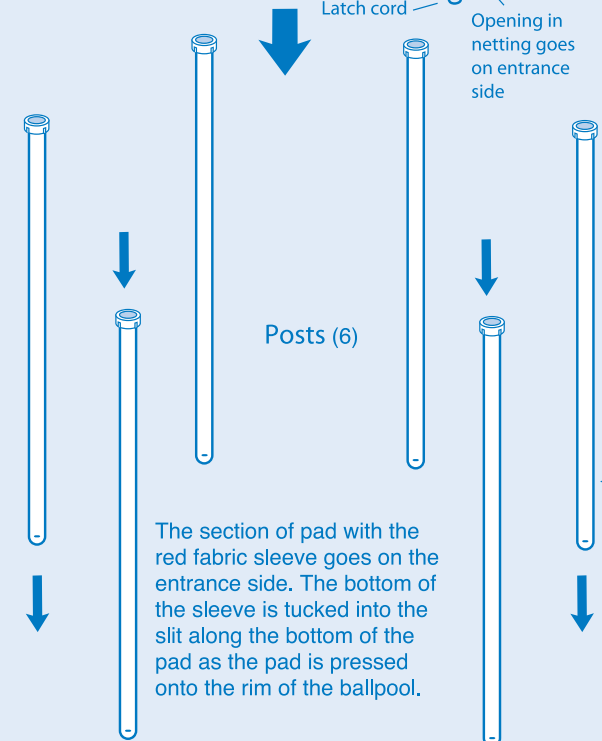
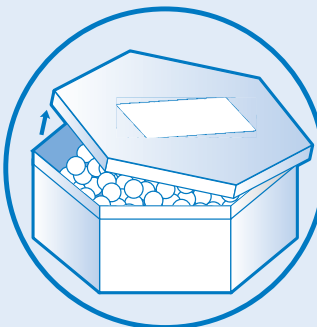

Finishing up

7. Use cable ties to tie down the foam pads and to anchor the netting through slots just below the pads on the rim of the Ballpool. Also use cable ties to tie off the netting to the posts. Be sure to leave the right side and bottom of the net at the entrance side **UNTIED**, so net may be folded back to allow kids to enter and exit the ballpool.

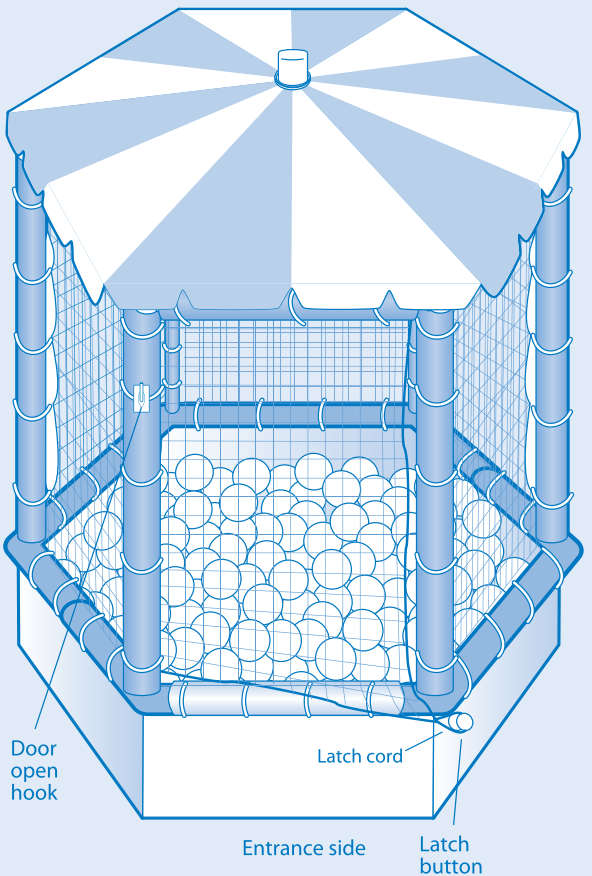
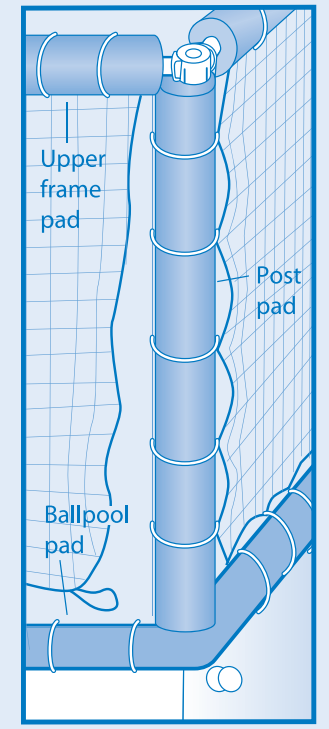
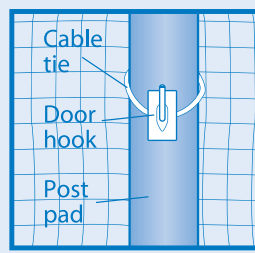
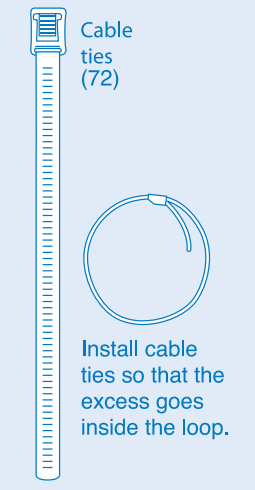

As cautioned in #7 above, do **NOT** tie off the net opening to the post at the right side of the entrance. **DO** tie off net on the other side of that post. The untied right and bottom of entrance net will be the "door" for kids to enter and exit. A loop at the bottom right corner of the net opening attaches to the latch button, closing the "door." Small hook to be installed near the top of post at left side of entrance, holds door open.

IMPORTANT! Follow instructions in proper sequence

Adult supervision is recommended for active play products.

Patent #'s: 6354004, 6093134

© 2005 Intertech Corporation All rights reserved.

for extra balls or replacement parts, visit:
www.giggleplay.com

The Balls in GigglePlay Gazebo™ feature exclusive:

